

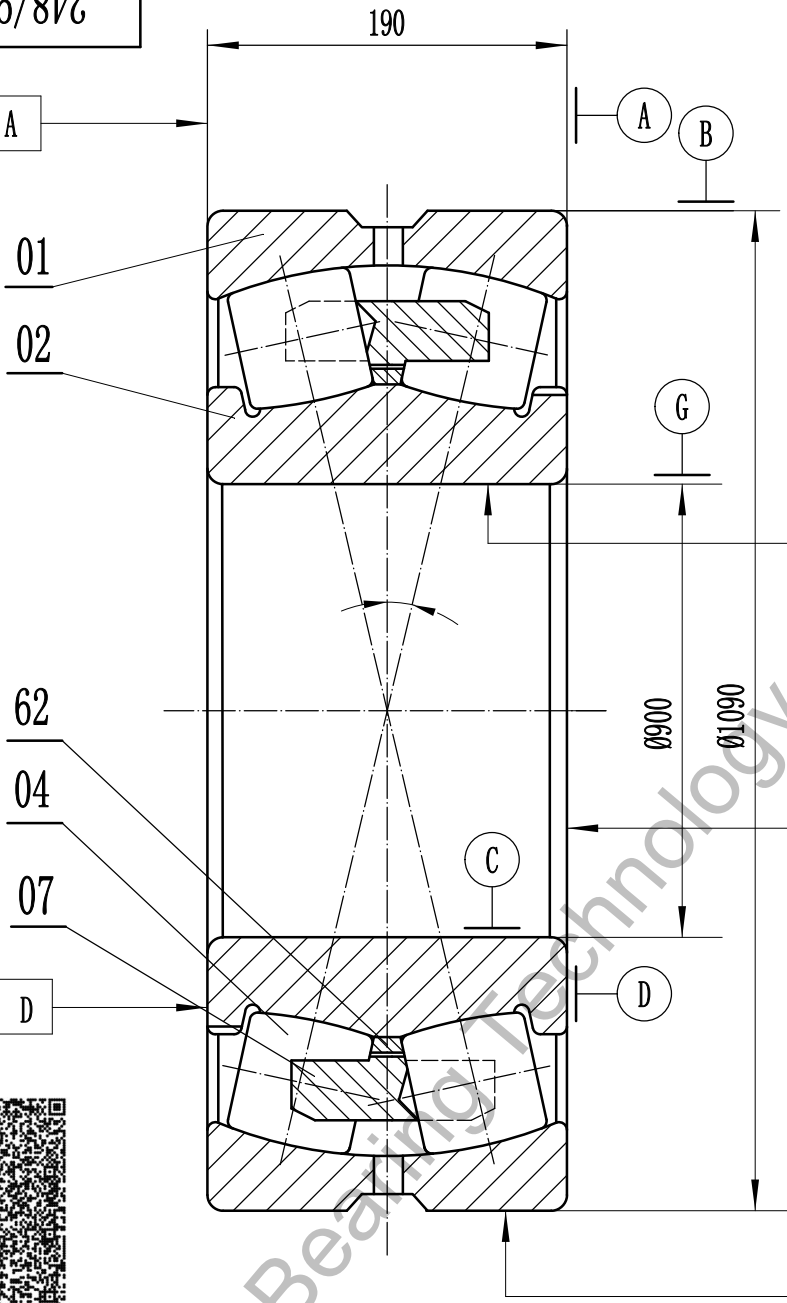

/// V_{Cs} A



⊖ V_{dsp}
 ⊘ V_{dmp}
 ⚡ K_{ia} B

⚡ S_d G

/// V_{Bs} D

⊖ V_{Dsp}
 ⊘ V_{Dmp}
 ⚡ K_{ea} C
 ✓ S_D A



- 1、Tolerance of running accuracy are according to relevant state standard;
- 2、The value of the basic group of radial clearance:min **** max ****;
- 3、Rated load: Cr= **** kN Cor= **** kN.

62	Guide ring	Steel 20—GB/T699			
07	Cage	Brass CuZn39Pb2—EN 1652:1997			
04	Roller	Steel 100CrMnSi6-4—ISO 683-17:1999			
02	Inner ring	Steel 100CrMnSi6-4—ISO 683-17:1999			
01	Outer ring	Steel 100CrMnSi6-4—ISO 683-17:1999			

No.	Designation	Qty	Material	unit	toatl	Remark
				Weight (kg)		

Luoyang JCB Bearing Technology Co., Ltd
 Contact information
 Company Address : No. 285, Fenghua road,
 Luoyang, Henan, China.
 Postal code : 471000
 Phone : 86-379-68611678
 Fax : 86-379-68611679
 E-mail: sales@jcb-bearing.com
 Reserved E-mail: sales@sphericalrollerbearing.net
 Website: www.jcb-bearing.com
 www.sphericalrollerbearing.net

Spherical Roller Bearing

248/900 CAMA/W20				
			Weight(kg)	Scale
S				—
Total page 5			Page No. 1	
Luoyang JCB Bearing Technology Co., Ltd				